

KEY WEST
ARMCHAIRS

roberto cavalli
HOME
INTERIORS



KEY WEST ARMCHAIRS

DESCRIPTION

Structure in multilayer wood and foam.
Upholstery in fabric or leather from the collection.
Wooden legs in the embossed lacquered finishings from the collection.
Optional metal back in Gold finishing.

DIMENSIONS

SWIVEL ARMCHAIR

C.KEY.221.A

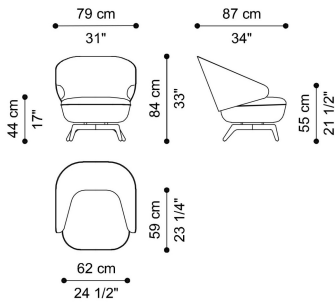

L 79 D 87 H 84 CM

OPTIONAL

METAL BACK
METAL GOLD - GLOSSY
C.COM.932.AMX

LEGS

WOOD

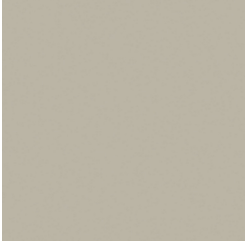

Desert lacquered wood - Embossed

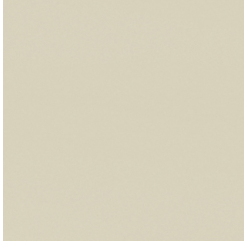

Ivory lacquered wood - Embossed

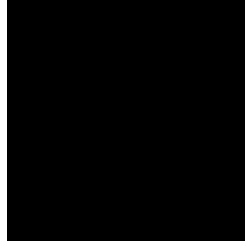

Black lacquered wood - Embossed

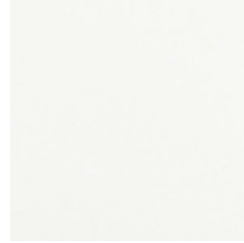

White lacquered wood - Embossed



Dark Brown lacquered wood - Embossed

UPHOLSTERY

FABRIC / LEATHER

 [download the file in the product page](#)

ACCESSORIES

DECORATIVE CUSHIONS

 [download the file in the product page](#)